

**Industrial Gigabit Switch
With 4 Port 802.3at PoE+**

IGS-504HPT / IGS-624HPT

User's Manual

Trademarks

Copyright © PLANET Technology Corp. 2015.

Contents are subject to revision without prior notice.

PLANET is a registered trademark of PLANET Technology Corp. All other trademarks belong to their respective owners

Disclaimer

PLANET Technology does not warrant that the hardware will work properly in all environments and applications, and makes no warranty and representation, either implied or expressed, with respect to the quality, performance, merchantability, or fitness for a particular purpose.

PLANET has made every effort to ensure that this User's Manual is accurate; PLANET disclaims liability for any inaccuracies or omissions that may have occurred.

Information in this User's Manual is subject to change without notice and does not represent a commitment on the part of PLANET. PLANET assumes no responsibility for any inaccuracies that may be contained in this User's Manual. PLANET makes no commitment to update or keep the current information in this User's Manual, and reserves the right to make improvements to this User's Manual and/or to the products described in this User's Manual, at any time without notice.

If you find information in this manual incorrect, misleading, or incomplete, we would appreciate your comments and suggestions.

FCC Warning

This equipment has been tested and found to comply with the limits for a Class A digital device, pursuant to Part 15 of the FCC Rules. These limits are designed to provide reasonable protection against harmful interference when the equipment is operated in a commercial environment. This equipment generates, uses, and can radiate radio frequency energy and, if not installed and used in accordance with the Instruction manual, may cause harmful interference to radio communications. Operation of this equipment in a residential area is likely to cause harmful interference in which case the user will be required to correct the interference at his own expense.

CE Mark Warning

This is a Class A product. In a domestic environment, this product may cause radio interference, in which case the user may be required to take adequate measures.

WEEE Warning



To avoid the potential effects on the environment and human health as a result of the presence of hazardous substances in electrical and electronic equipment, end users of electrical and electronic equipment should understand the meaning of the crossed-out wheeled bin symbol. Do not dispose of WEEE as unsorted municipal waste; they should be collected separately

Revision

User's Manual of PLANET Industrial Gigabit Switch with 4-port 802.3at PoE+

For Model: IGS-504HPT / IGS-624HPT

Revision: 1.2 (April, 2015)

Part No: EM-IGS-504HPT_624HPT_v1.2 (2350-AH0600-002)

Table Of Contents

1. Introduction	5
1.1 Package Contents	5
1.2 How to Use This Manual.....	5
1.3 Product Features	6
1.4 Product Specifications	7
1.5 Physical Dimensions.....	10
2. Installation	12
2.1 Product Description.....	12
2.1.1 Switch Front Panel	13
2.1.2 LED Indicators	14
2.1.3 Switch Upper Panel	15
2.1.4 Wiring the Power Inputs	16
2.1.5 Wiring the Faulty Alarm Contact	17
2.1.6 Cabling.....	17
2.1.7 Redundancy Overview.....	23
2.2 Mounting Installation	24
2.2.1 DIN-rail mounting	24
2.2.2 Wall-mount Plate Mounting.....	26
3. Applications.....	27
4. Switch Operation	29
4.1 Address Table.....	29
4.2 Learning	29
4.3 Forwarding & Filtering	29
4.4 Store-and-Forward.....	29
4.5 Auto-Negotiation	30
5. Troubleshooting	31
6. Cable Connection Parameters.....	32
APPENDIX A: Networking Connection.....	33
A.1 PoE RJ45 Port Pin Assignments (End-Span).....	33
A.2 Switch's RJ45 Pin Assignments.....	33
A.3 RJ45 Cable Pin Assignments	34

1. Introduction

Thank you for purchasing PLANET Industrial Gigabit Switch with 4-Port 802.3at PoE+, IGS-504HPT/IGS-624HPT. The descriptions of these models are as follows:

IGS-504HPT : Industrial 5-Port Gigabit Switch with 4-Port 802.3at PoE+ (-40~75 degrees C)

IGS-624HPT : Industrial 4-Port 10/100/1000T 802.3at PoE+ 2-Port 100/1000X SFP Ethernet Switch (-40~75 degrees C)

In this user's manual, the term "**Industrial Gigabit PoE+ Switch**" means the IGS-504HPT and IGS-624HPT.

1.1 Package Contents

Open the box of the Industrial Gigabit PoE+ Switch and carefully unpack it. The box should contain the following items:

- Industrial Gigabit PoE+ Switch x 1
- User's Manual x 1
- DIN Rail Kit x 1
- Wallmount Kit x 1
- Dust Cap:

Model	RJ45 Dust Cap	SFP Dust Cap
IGS-504HPT	5	--
IGS-624HPT	4	2

If any of these are missing or damaged, please contact your dealer immediately; if possible, retain the carton including the original packing material, and use them again to repack the product in case there is a need to return it to us for repair.

1.2 How to Use This Manual

This Industrial Gigabit PoE+ Switch User Manual is structured as follows:

Chapter 2 Installation

The chapter explains the feature, functionality and the physical installation of the Industrial Gigabit PoE+ Switch.

Chapter 3 Application

The chapter explains the Industrial Gigabit PoE+ Switch application.

Chapter 4 Switch operation

The chapter explains the Industrial Gigabit PoE+ Switch transmit operation.

Chapter 5 Troubleshooting

The chapter explains the troubleshooting of the Industrial Gigabit PoE+ Switch.

Chapter 6 Cable Connection Parameters

The chapter contains the cable connection parameters of the Industrial Gigabit PoE+ Switch.

Appendix A

This chapter contains cable information of the Industrial Gigabit PoE+ Switch.

1.3 Product Features

Physical Port

IGS-504HPT

- 5-Port 10/100/1000BASE-T RJ45 with 4-Port **IEEE 802.3af/802.3at PoE+** injector

IGS-624HPT

- 4-Port 10/100/1000BASE-T RJ45 with **IEEE 802.3af/802.3at PoE+** Injector
- 2 SFP interfaces, 100/1000BASE-X dual mode (DIP switch control)

Power over Ethernet

- Complies with IEEE 802.3af/IEEE 802.3at Power over Ethernet Plus End-Span PSE
- Up to 4 IEEE 802.3af/802.3at devices powered
- Supports PoE Power up to 30.8 watts for each PoE port
- Provides 52V DC power over RJ45 Ethernet cable to PD with Ethernet port
- Auto-detection of IEEE 802.3af/at equipments and protects devices from being damaged by incorrect installation
- Remote power feeding up to 100m

Layer 2 Features

- Supports auto-negotiation and 10/100Mbps half/full duplex and 1000Mbps full duplex mode
- Prevents packet loss with back pressure (half-duplex) and IEEE 802.3x pause frame flow control (half-duplex)
- Automatic address learning and address aging

Industrial Case/Installation

- IP30 aluminum metal case protection
- DIN rail and wall-mount design

- 48V DC redundant power with polarity reverse protect function and connective removable terminal block for master and slave power
- Supports EFT protection 6000V DC for power line
- Supports 6000V DC Ethernet ESD protection
- -40 to 75 degrees C operating temperature

Fiber Port Redundancy (IGS-624HPT Only)

- Dual SFP ports with auto link redundancy
- Auto-detects link status and redundant dual ports with the same connector type
- Only Primary Port is active at a time; the Backup Port is blocked
- When Primary Port link fails, the traffic swaps to Backup Port automatically.
- Once the Primary Port status is connected, the traffic swaps from Backup Port to Primary Port

1.4 Product Specifications

Model	IGS-504HPT	IGS-624HPT
Hardware Specifications		
Copper Ports	5 x 10/100/1000BASE-T RJ45 TP Auto-MDI/MDI-X, auto-negotiation	4 x 10/100/1000BASE-T RJ45 TP Auto-MDI/MDI-X, auto-negotiation
SFP/mini-GBIC Slots	—	2 x SFP interfaces Supports 1000BASE-SX/ LX and 100BASE-FX SFP transceivers
DIP Switch	—	DIP-1: SFP Port 5 1000BASE-X (default) / 100BASE-FX DIP-2: SFP Port 6 1000BASE-X (default) / 100BASE-FX DIP-3: Switch (default) / fiber redundant mode
Connector	Terminal Block Pin 1/2 for Power 1; Pin 3/4 for alarm; Pin 5/6 for Power 2	
Alarm	Provides one relay output for power failure Alarm relay current carry ability: 1A @ 24V DC	

LED	<p>3 x LED for System and Power:</p> <ul style="list-style-type: none"> ■ Green: DC Power 1 ■ Green: DC Power 2 ■ Green: Power Fault <p>2 x LED for each copper port (Port-1~Port-4):</p> <ul style="list-style-type: none"> ■ Green: 1000 LNK/ACT, Orange: 100 LNK/ACT ■ Orange: PoE In-use <p>1 x LED for each mini-GBIC interface (IGS-624HPT Port-5 and Port-6):</p> <ul style="list-style-type: none"> ■ Green: LNK/ACT <p>1 x LED for Per Copper port (IGS-504HPT):</p> <ul style="list-style-type: none"> ■ Green: 1000 LNK/ACT ■ Orange: 100 LNK/ACT <p>4 x LED for PoE Power Usage (W):</p> <ul style="list-style-type: none"> ■ Orange: 30, 60, 90 and 120W 	
ESD Protection	6KV DC	
EFT Protection	6KV DC	
Enclosure	IP30 type metal case	
Installation	DIN rail kit and wall mount ear	
Dimensions	152 x 107 x 72mm	
Weight	1478g	1539g
Power Requirement	48V DC, 5A max. Redundant power with polarity reverse protection	
Power Consumption/ Dissipation	134.1 watts / 451 BTU	135.1 watts / 461 BTU
Cable	Twisted-Pair	10BASE-T: 2-Pair UTP Cat3,4,5, up to 100 meters 100BASE-TX: 2-Pair UTP Cat5, 5e up to 100 meters 1000BASE-T: 4-Pair UTP Cat5e,6 up to 100 meters
	Fiber-Optic Cable	1000BASE-SX : 50/125µm or 62.5/125µm multi-mode fiber optic cable, up to 550m 1000BASE-LX : 9/125µm single-mode fiber optic cable, up to 10/20/30/40/50/70/120 kilometers (varies on SFP module) 100BASE-FX : 50/125µm or 62.5/125µm multi-mode fiber optic cable, up to 2 kilometers 9/125µm single-mode fiber optic cable, up to 20/40/60 kilometers (varies on SFP module)

Switch Specifications		
Switch Processing Scheme	Store-and-Forward	
Address Table	1K entries	
Flow Control	Back pressure for half duplex IEEE 802.3x pause frame for full duplex	
Switch fabric	10Gbps	12Gbps
Throughput (packet per second)	7.44Mpps@64bytes	8.93Mpps@64bytes
Maximum Transmit Unit	9216 bytes	
Speed	TP: 10/20Mbps, 100/200Mbps, 2000Mbps SX/LX: 2000Mbps (full-duplex) FX: 200Mbps (full-duplex)	
Power over Ethernet		
PoE Standard	IEEE 802.3af/IEEE 802.3at Power over Ethernet/PSE	
PoE Power Supply Type	End-Span	
PoE Power Output	Per port 52V DC, 275mA. Max. 15.4 watts (IEEE 802.3af) Per port 52V DC, 535mA. Max. 30 watts (IEEE 802.3at)	
Power Pin Assignment	1/2(+), 3/6(-)	
Max. number of Class 4 PD	4	
Standards Conformance		
Standards Compliance	IEEE 802.3 Ethernet/10BASE-T IEEE 802.3u Fast Ethernet/100BASE-TX IEEE 802.3ab Gigabit Ethernet/1000BASE-T IEEE 802.3z Gigabit Ethernet/1000BASE-SX/LX IEEE 802.3x full-duplex flow control IEEE 802.3at Power over Ethernet Plus IEEE 802.3af Power over Ethernet	
Regulation Compliance	FCC Part 15 Class A, CE	
Stability Testing	IEC60068-2-32 (free fall) IEC60068-2-27 (shock) IEC60068-2-6 (vibration)	
Environment		
Temperature	Operating: -40~75 degrees C Storage: -40~75 degrees C	
Humidity	Operating: 5~95% (non-condensing) Storage: 5~95% (non-condensing)	

1.5 Physical Dimensions

- IGS-504HPT Industrial Gigabit PoE+ Switch dimensions (W x D x H): 161 x 107 x 72 mm

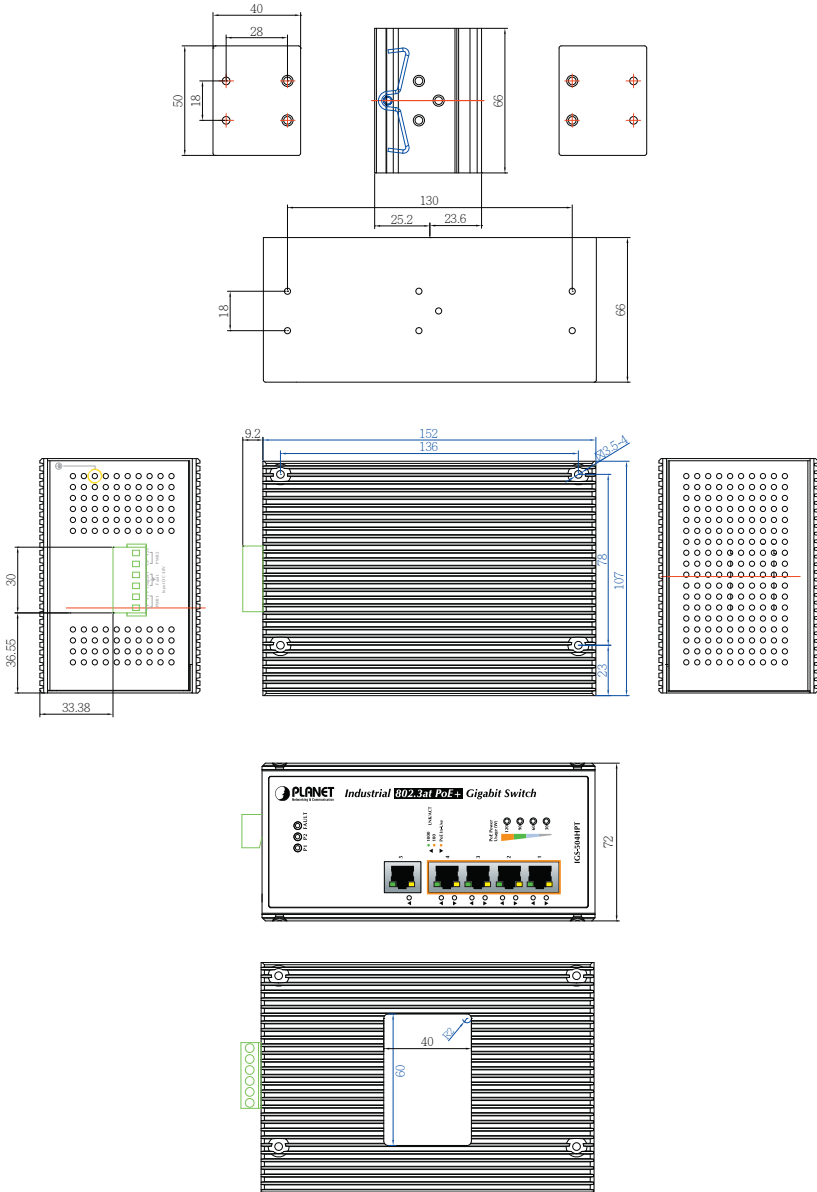

■ IGS-624HPT Industrial Gigabit PoE+ Switch dimensions (W x D x H): 161 x 107 x 72 mm

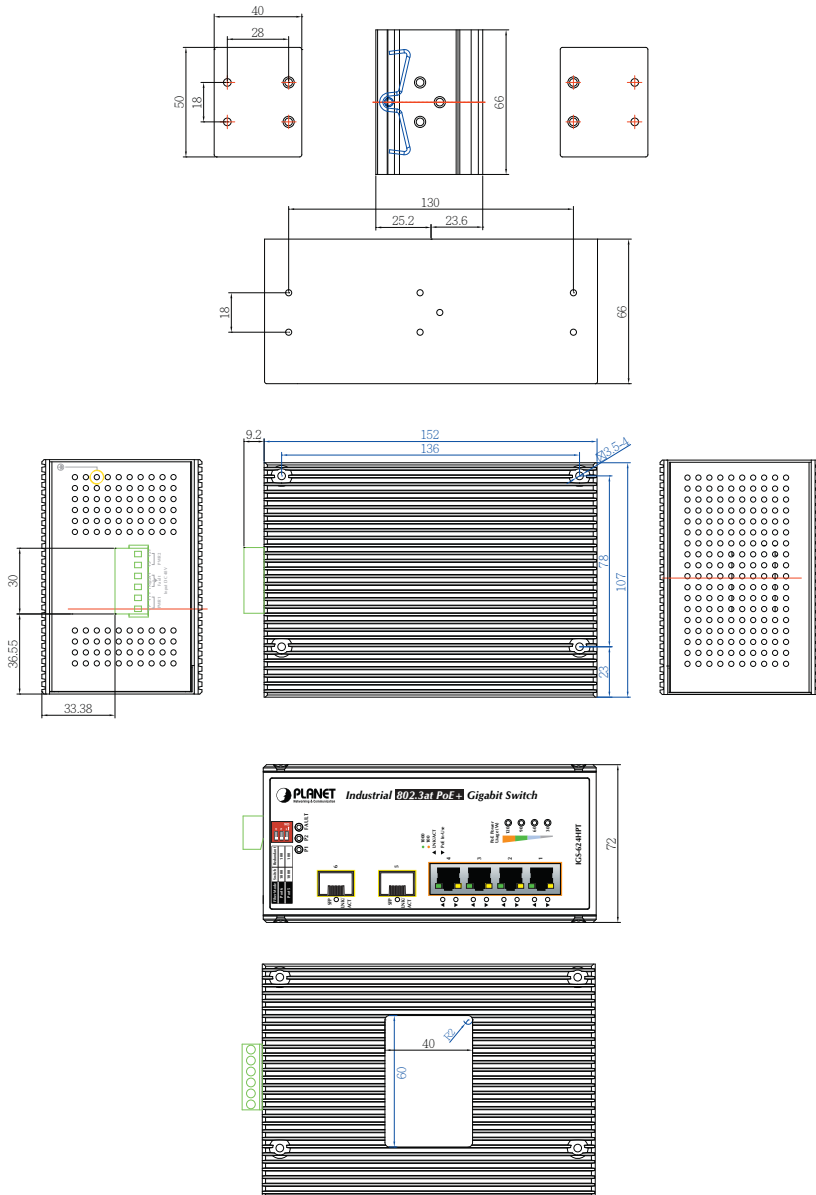

2. Installation

This section describes the functionalities of the Industrial Gigabit PoE+ Switch's components and guides you to how to install it on the desk. Basic knowledge of networking is assumed. Please read this chapter completely before continuing.

2.1 Product Description

High Power PoE for Security and Public Service Applications

To fulfill the demand of High Power PoE for network applications with Gigabit speed transmission under wide temperature, the IGS-504HPT and IGS-624HPT provide 4 10/100/1000Mbps ports featuring both IEEE 802.3af and IEEE 802.3at Power over Ethernet Plus (PoE+) that combine up to 30-watt power output and data per port over one Cat.5E / 6 Ethernet cable.

With a total of up to 120 watts of PoE output capability, the IGS-504HPT and IGS-624HPT are designed specifically to satisfy the growing demand of higher power consuming network PDs (powered devices) such as PTZ (Pan, Tilt & Zoom) speed dome network cameras, multi-channel (802.11a / b / g / n) wireless LAN access points and other PoE network devices by providing double PoE power, rather than the current conventional 802.3af PoE.

Environmentally Hardened Design

The IGS-504HPT and IGS-624HPT are equipped with rugged IP30 metal case for easy deployment in heavy Industrial demanding environments. With IP30 metal case protection, the IGS-504HPT and IGS-624HPT provide a high level of immunity against electromagnetic interference and heavy electrical surges which are usually found on plant floors or in curb side traffic control cabinets. Being able to operate in the temperature range from -40 to 75 degrees C, the IGS-504HPT and IGS-624HPT can be placed in almost any difficult environment. The IGS-504HPT and IGS-624HPT allows either DIN rail or wall mounting for efficient use of cabinet space.

Adjustable 6-Port Switch Mode or 4 + 2 Fiber Redundant Mode

Via the built-in DIP switch, the IGS-624HPT can be configured as 6-Port Ethernet switch or 4+2 fiber redundant mode. With the 6-port switch mode, the IGS-624HPT can operate in Store-and-Forward mechanism with high performance; on the other hand, when in the 4+2 fiber redundant mode, it provides rapid fiber redundancy of link for highly critical Ethernet applications. The redundant-mode also supports auto-recovering function. If the destination port of a packet is link down, it will forward the packet to the other port of the backup pair.

2.1.1 Switch Front Panel

Figure 2-1 shows the front panels of IGS-504HPT and IGS-624HPT Industrial Gigabit PoE+ Switches.

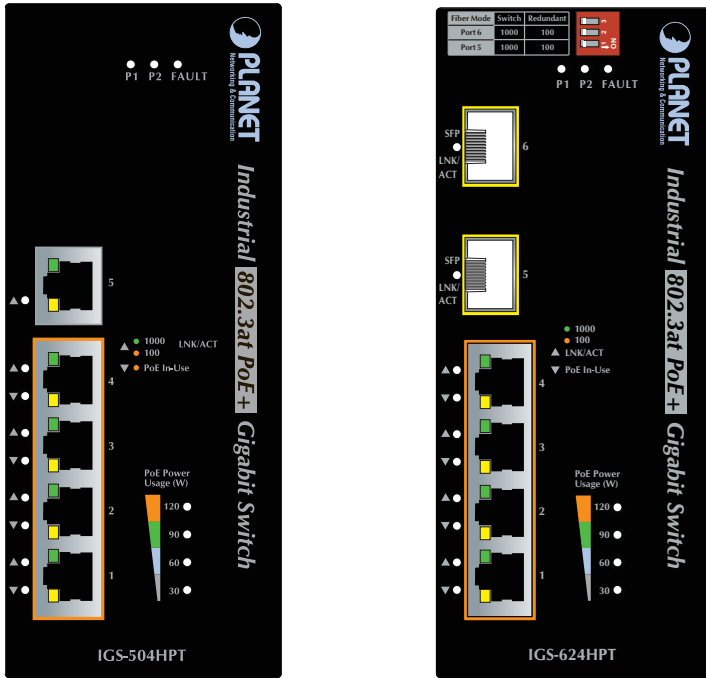
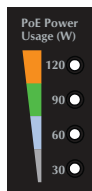

Figure 2-1: IGS-504HPT & IGS-624HPT Front Panels

■ PoE Power Usage LED

The front panel of the Industrial Gigabit PoE+ Switch has four LEDs which indicate **PoE Power Usages of 30W, 60W, 90W and 120W**. With these LED indications, you can monitor the current PoE power in use status of Industrial Gigabit PoE+ Switch easily and efficiently.



■ DIP Switch

The front panel of the IGS-624HPT provides one 3-DIP Switch which is for configuring 100 or 1000X fiber support and fiber redundant function.

Refer to the table below to know about the 3-DIP switch settings and descriptions:

For more information about the fiber redundancy function, please refer to Chapter 2.1.7 Redundancy Overview.



	OFF	ON
Fiber Redundant (DIP 3)	Switch	Fiber Redundant
Port 6 (DIP 2)	1000X	100FX
Port 5 (DIP 1)	1000X	100FX

2.1.2 LED Indicators

System

LED	Color	Function
P1	Green	Light: indicates power 1 has power.
P2	Green	Light: indicates power 2 has power.
FAULT	Green	Light: indicates either power 1 or power 2 has no power.

10/100/1000BASE-T Interfaces

LED	Color	Function
LNK/ACT	Green	Light: indicates the Switch is successfully connecting to the network at 1000Mbps.
		Blink: indicates that the Switch is actively sending or receiving data over that port.
		Off: indicates that the Switch is inactively sending or receiving data over that port.
	Orange	Light: indicates the Switch is successfully connecting to the network at 10Mbps or 100Mbps.
		Blink: indicates that the Switch is actively sending or receiving data over that port.
		Off: indicates that the Switch is inactively sending or receiving data over that port.
PoE in-Use (Port 1~4)	Orange	Light: indicates the port is providing 52V DC in-line power.
		Off: indicates the connected device is not a PoE Powered Device (PD).

100/1000BASE-X SFP Interfaces (IGS-624HPT)

LED	Color	Function
LNK/ACT	Green	Light: indicates the Switch is successfully connecting to the network at 100/1000Mbps.
		Blink: indicates that the Switch is actively sending or receiving data over that port.
		OFF: indicates that the Switch is inactively sending or receiving data over that port.

Per PoE Power Usage (Unit : Watt) (Lower LED to upper LED)

LED	Color	Function
30	Orange	Light: indicates the system is providing >30/60/90/120W PoE power usage.
60		Blink: indicates the system is providing 30/60/90/120W PoE power usage.
90		25 < X < 30, 30W LED flash; X >= 30, 30W LED light;
120		55 < X < 60, 60W LED flash; X >= 60, 60W LED light;
		85 < X < 90, 90W LED flash; X >= 90, 90W LED light;
		100 < X < 115, 120W LED flash;
		115 < X < 120, 120W LED flash fast; X >= 120, 120W LED light.

2.1.3 Switch Upper Panel

The upper panel of the Industrial Gigabit PoE+ Switch consists of one terminal block connector within two DC power inputs. Figure 2-2 shows the upper panel of the Switch.

Figure 2-2 shows upper panel of Industrial Gigabit PoE+ Switch.

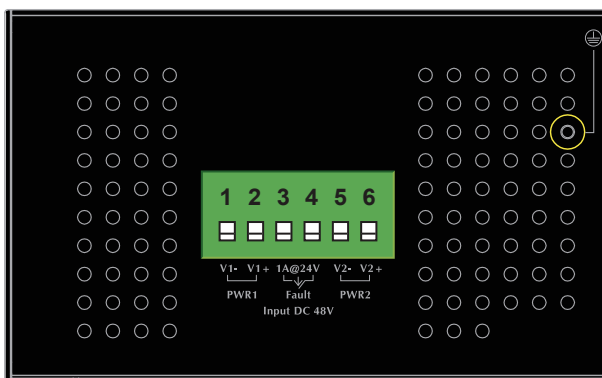
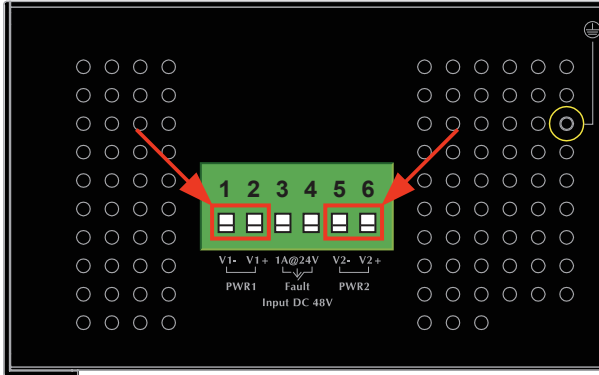

Figure 2-2: Industrial Gigabit PoE Switch Upper Panel.

2.1.4 Wiring the Power Inputs

The 6-contact terminal block connector on the top panel of Industrial Gigabit PoE+ Switch is used for two DC redundant powers input. Please follow the steps below to insert the power wire.

1. Insert positive/negative DC power wires into contacts 1 and 2 for Power 1, or 5 and 6 for power.



V1- V1+ V2 - V2+

2. Tighten the wire-clamp screws for preventing the wires from loosening.

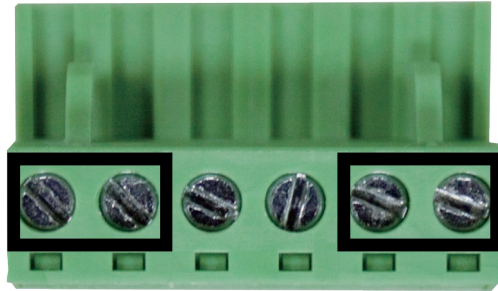

1 2 3 4 5 6
Power 1 Fault Power 2
- + - +



Note

The wire gauge for the terminal block should be in the range between 12 and 24 AWG.

2.1.5 Wiring the Faulty Alarm Contact

The faulty alarm contacts are in the middle of the terminal block connector as the picture shows below. Inserting the wires, the Industrial Gigabit PoE+ Switch will detect the fault status of the power failure, or port link failure (available for managed model) and then forms an open circuit. The following illustration shows an application example for wiring the faulty alarm contacts.

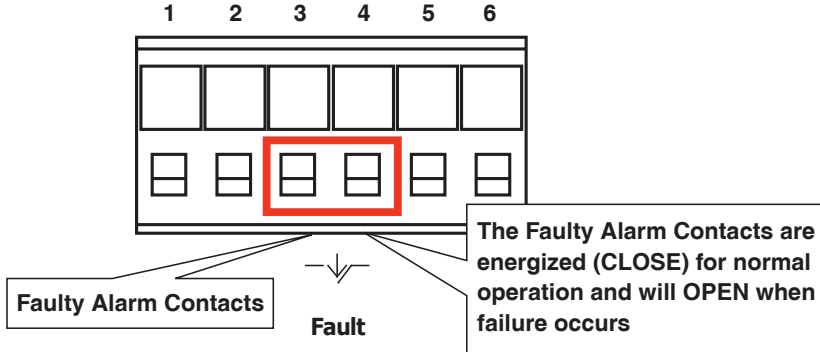

Note

1. The wire gauge for the terminal block should be in the range of 12 ~ 24 AWG.
2. Alarm relay circuit accepts up to 30V, max. 3A currents.

2.1.6 Cabling

10/100/1000BASE-T

All 10/100/1000BASE-T ports come with Auto-Negotiation capability. They automatically support 1000BASE-T, 100BASE-TX and 10BASE-T networks. Users only need to plug a working network device into one of the 10/100/1000BASE-T ports, and then turn on the Industrial Gigabit PoE+ Switch. The port will automatically runs in 10Mbps, 20Mbps, 100Mbps or 200Mbps and 1000Mbps or 2000Mbps after the negotiation with the connected device.

100BASE-FX/1000BASE-SX/LX

The IGS-624HPT Industrial Gigabit PoE+ Switch has two SFP interfaces that support 100/1000 dual speed mode (optional multi-mode/single-mode 100BASE-FX/1000BASE-SX/LX SFP module) through DIP switch setting.

Cabling

Each 10/100/1000BASE-T port uses RJ45 sockets -- similar to phone jacks -- for connection of unshielded twisted-pair cable (UTP). The IEEE 802.3/802.3u/802.3ab

Fast/Gigabit Ethernet standard requires Category 5 UTP for 100Mbps 100BASE-TX. 10BASE-T networks can use Cat3, 4, 5 or 1000BASE-T uses 5/5e/6 UTP (see table below). Maximum distance is 100 meters (328 feet). The 100BASE-FX/1000BASE-SX/LX SFP slot is used as LC connector with optional SFP module. Please see table below and know more about the cable's specification.

Port Type	Cable Type	Connector
10BASE-T	Cat3, 4, 5, 2-pair	RJ45
100BASE-TX	Cat5 UTP, 2-pair	RJ45
1000BASE-T	Cat5/5e/6 UTP, 4-pair	RJ45
100BASE-FX	50/125µm or 62.5/125µm multi-mode 9/125µm single-mode	LC (multi/single mode)
1000BASE-SX/ LX	50/125µm or 62.5/125µm multi-mode 9/125µm single-mode	LC (multi/single mode)

Any Ethernet devices like hubs/PCs can be connected to the Industrial Gigabit PoE+ Switch by using straight-through wires. The four 10/100/1000Mbps ports are auto-MDI/MDI-X and can be used on straight-through or crossover cable.

2.1.6.1 Installing the SFP transceiver

The sections describe how to insert an SFP transceiver into the IGS-624HPT SFP slot.

The SFP transceivers are hot-pluggable and hot-swappable. You can plug in and out the transceiver to/from any SFP port without having to power down the Industrial Gigabit PoE+ Switch as the Figure 2-3 appears.



Figure 2-3: Plug-in the SFP transceiver

■ Approved PLANET SFP Transceivers

PLANET Industrial Gigabit PoE+ Switch supports both single mode and multi-mode SFP transceivers. The following list of approved PLANET SFP transceivers is correct at the time of publication:

Fast Ethernet Transceiver (100BASE-X SFP)

Model	Speed (Mbps)	Connector Interface	Fiber Mode	Distance	Wavelength (nm)	Operating Temp.
MFB-FX	100	LC	Multi Mode	2km	1310nm	0 ~ 60°C
MFB-F20	100	LC	Single Mode	20km	1310nm	0 ~ 60°C
MFB-F40	100	LC	Single Mode	40km	1310nm	0 ~ 60°C
MFB-F60	100	LC	Single Mode	60km	1310nm	0 ~ 60°C
MFB-F120	100	LC	Single Mode	120km	1550nm	0 ~ 60°C
MFB-TFX	100	LC	Multi Mode	2km	1310nm	-40 ~ 75°C
MFB-TF20	100	LC	Single Mode	20km	1550nm	-40 ~ 75°C

Fast Ethernet Transceiver (100BASE-BX, Single Fiber Bi-Directional SFP)

Model	Speed (Mbps)	Connector Interface	Fiber Mode	Distance	Wavelength (TX)	Wavelength (RX)	Operating Temp.
MFB-FA20 MFB-FB20	100	WDM (LC)	Single Mode	20km	1310nm 1550nm	1550nm 1310nm	0 ~ 60°C
MFB-TFA20 MFB-TFB20	100	WDM (LC)	Single Mode	20km	1310nm 1550nm	1550nm 1310nm	-40 ~ 75°C
MFB-TFA40 MFB-TFB40	100	WDM (LC)	Single Mode	40km	1310nm 1550nm	1550nm 1310nm	-40 ~ 75°C

Gigabit Ethernet Transceiver (1000BASE-X SFP)

Model	Speed (Mbps)	Connector Interface	Fiber Mode	Distance	Wavelength (nm)	Operating Temp.
MGB-GT	1000	Copper	--	100m	--	0 ~ 60°C
MGB-SX	1000	LC	Multi Mode	550m	850nm	0 ~ 60°C
MGB-SX2	1000	LC	Multi Mode	2km	1310nm	0 ~ 60°C
MGB-LX	1000	LC	Single Mode	10km	1310nm	0 ~ 60°C
MGB-L30	1000	LC	Single Mode	30km	1310nm	0 ~ 60°C
MGB-L40	1000	LC	Single Mode	40km	1550nm	0 ~ 60°C
MGB-L50	1000	LC	Single Mode	50km	1550nm	0 ~ 60°C
MGB-L70	1000	LC	Single Mode	70km	1550nm	0 ~ 60°C

MGB-L120	1000	LC	Single Mode	120km	1550nm	0 ~ 60°C
MGB-TSX	1000	LC	Multi Mode	550m	850nm	-40 ~ 75°C
MGB-TLX	1000	LC	Single Mode	10km	1310nm	-40 ~ 75°C
MGB-TL30	1000	LC	Single Mode	30km	1310nm	-40 ~ 75°C
MGB-TL50	1000	LC	Single Mode	50km	1550nm	-40 ~ 75°C

Gigabit Ethernet Transceiver (1000BASE-BX, Single Fiber Bi-Directional SFP)

Model	Speed (Mbps)	Connector Interface	Fiber Mode	Distance	Wavelength (TX)	Wavelength (RX)	Operating Temp.
MGB-LA10 MGB-LB10	1000	WDM (LC)	Single Mode	10km	1310nm 1550nm	1550nm 1310nm	0 ~ 60°C
MGB-LA20 MGB-LB20	1000	WDM (LC)	Single Mode	20km	1310nm 1550nm	1550nm 1310nm	0 ~ 60°C
MGB-LA40 MGB-LB40	1000	WDM (LC)	Single Mode	40km	1310nm 1550nm	1550nm 1310nm	0 ~ 60°C
MGB-LA60 MGB-LB60	1000	WDM (LC)	Single Mode	60km	1310nm 1550nm	1550nm 1310nm	0 ~ 60°C
MGB-TLA10 MGB-TLB10	1000	WDM (LC)	Single Mode	10km	1310nm 1550nm	1550nm 1310nm	-40 ~ 75°C
MGB-TLA20 MGB-TLB20	1000	WDM (LC)	Single Mode	20km	1310nm 1550nm	1550nm 1310nm	-40 ~ 75°C
MGB-TLA40 MGB-TLB40	1000	WDM (LC)	Single Mode	40km	1310nm 1550nm	1550nm 1310nm	-40 ~ 75°C
MGB-TLA60 MGB-TLB60	1000	WDM (LC)	Single Mode	60km	1310nm 1550nm	1550nm 1310nm	-40 ~ 75°C



Note

It is recommended to use PLANET SFP transceivers on the Industrial Gigabit PoE+ Switch. If you insert an SFP transceiver that is not in the supported list, the Industrial Gigabit PoE+ Switch might not recognize it.

1000BASE-SX/LX:

Before connecting with switches, workstation or media converter, please do the following steps:

1. With 1000BASE-X Fiber Speed, please set the DIP Switch of SFP Port 5 or Port 6 to the "OFF" position.

	OFF	ON
Port 6 (DIP 2)	1000X	100FX
Port 5 (DIP 1)	1000X	100FX



2. Make sure both sides of the SFP transceivers are with the same media type, for example: 1000BASE-SX to 1000BASE-SX, 1000BASE-LX to 1000BASE-LX.
3. Check whether the fiber-optic cable type matches with the SFP transceiver model.
 - To connect to 1000BASE-SX SFP transceiver, use the multi-mode fiber cable with one side being the male duplex LC connector type.
 - To connect to 1000BASE-LX SFP transceiver, use the single-mode fiber cable with one side being the male duplex LC connector type.

Connecting the fiber cable

1. Insert the duplex LC connector on the network cable into the SFP transceiver.
2. Connect the other end of the cable to a device – switches with SFP installed, fiber NIC on a workstation or a media converter.
3. Check the LNK/ACT LED of the SFP slot on the front of the Industrial Gigabit PoE+ Switch. Ensure that the SFP transceiver is operating correctly.

100BASE-FX:

Before connecting with switches, workstation or media converter, please do the following steps:

1. With 100BASE-FX Fiber Speed, please set the DIP Switch (SFP Port 5 or Port 6) to the "ON" position.

	OFF	ON
Port 6 (DIP 2)	1000X	100FX
Port 5 (DIP 1)	1000X	100FX



2. Make sure both sides of the SFP transceivers are with the same media type or WDM pair, for example, 100BASE-FX to 100BASE-FX, 100BASE-BX20-U to 100BASE-BX20-D.

3. Check whether the fiber-optic cable type matches with the SFP transceiver model.
 - To connect to MFB-FX SFP transceiver, use the multi-mode fiber cable with one side being the male duplex LC connector type.
 - To connect to MFB-F20/F40/F60/FA20/FB20 SFP transceiver, use the single-mode fiber cable with one side being the male duplex LC connector type.

Connecting the fiber cable

1. Insert the duplex LC connector on the network cable into the SFP transceiver.
2. Connect the other end of the cable to a device – switches with SFP installed, to fiber NIC on a workstation or a media converter.
3. Check the LNK/ACT LED of the SFP slot of the switch/converter. Ensure that the SFP transceiver is operating correctly.

2.1.6.2 Removing the Transceiver Module

1. Make sure there is no network activity by consulting or checking with the network administrator. Or through the management interface of the switch/converter (if available), disable the port in advance.
2. Remove the Fiber Optic Cable gently.
3. Turn the latch of the MGB/MFB module to a horizontal position.
4. Pull out the module gently through the latch.



Figure 2-4: Pulling out from the transceiver



Note

Never pull out the module without pulling the latch or the push bolts on the module. Directly pulling out the module with force could damage the module and the SFP module slot of the Industrial Gigabit Ethernet Switch.

2.1.7 Redundancy Overview

The IGS-624HPT Industrial Gigabit PoE+ Switch provides rapid fiber redundancy of link for highly critical Ethernet applications. The redundant-mode supports auto-recover function. If the destination port of a packet is link down, it forwards the packet to the other port of the backup pair. The following figure shows the redundant function.

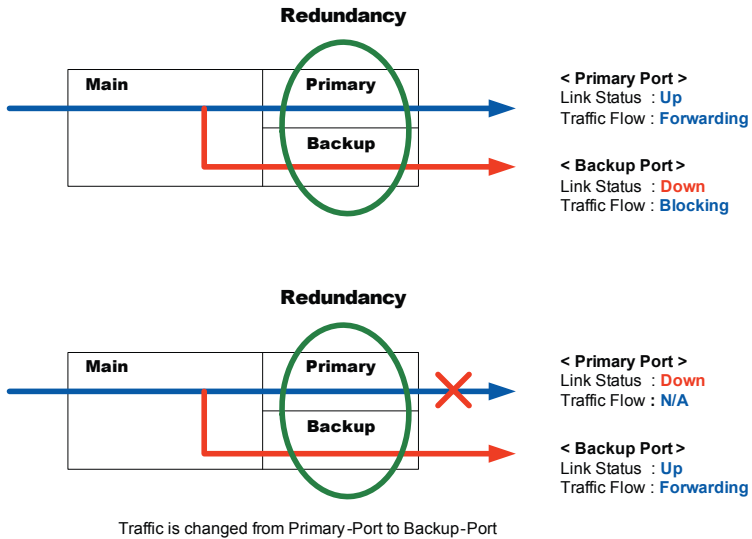

Figure 2-5: Redundancy Behavior Topology

- Auto-detects link status and redundant dual ports with the same connector type
- Only Primary Port is active at a time, the Backup Port is blocked.
- When Primary Port link failure occurs, the traffic swaps to Backup Port automatically.
- Once the Primary Port status is connected, the traffic will swap from Backup Port to Primary Port.

2.2 Mounting Installation

This section describes how to install the Industrial Gigabit PoE+ Switch and make connections to it. Please read the following topics and perform the procedures in the order being presented.



Note

In the installation steps below, this Manual uses IGS-801 (PLANET 8 Port Industrial Gigabit Switch) as the example. However, the steps for PLANET Industrial Gigabit PoE+ Switch are similar.

2.2.1 DIN-rail mounting

The DIN-rail is screwed on the Industrial Gigabit Ethernet Switch when out of factory. When needed to replace the wall mount application with the DIN-rail application on Industrial Gigabit Ethernet Switch, please refer to the following figures to screw the DIN-rail on the Industrial Gigabit Ethernet Switch. To hang the Industrial Gigabit Ethernet Switch, follow the steps below:



Step 1: Screw the DIN-rail on the Industrial Gigabit Ethernet Switch.

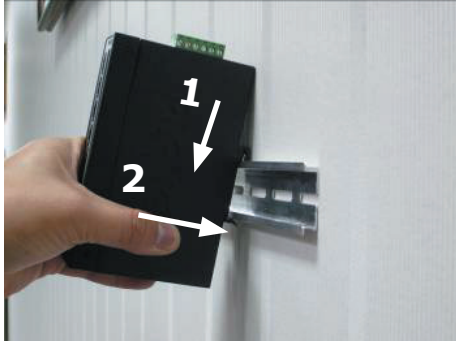

Step 2: Lightly insert the bottom of the switch into the track



Step 3: Check if the DIN-rail is tightly on the track.

Step 4: Please refer to the following procedures to remove the Industrial Gigabit Ethernet Switch from the track.



Step 5: Lightly pull out the bottom of the switch for removing it from the track.

2.2.2 Wall-mount Plate Mounting

To install the Industrial Gigabit Ethernet Switch on the wall, please follow the instructions described below.

Step 1: To remove the DIN-rail from the Industrial Gigabit Ethernet Switch, loosen the screws to remove the DIN-rail.

Step 2: Place the wall-mount plate on the rear panel of the Industrial Gigabit Ethernet Switch.



Step 3: Use the screws to screw the wall-mount plate on the Industrial Gigabit Ethernet Switch.

Step 4: Use the hook holes at the corners of the wall-mount plate to hang the Industrial Gigabit Ethernet Switch on the wall.

Step 5: To remove the wall-mount plate, reverse the steps above.

3. Applications

In this paragraph, we will describe how to install Industrial Gigabit PoE+ Switch and the installation points.

Industrial Operating Environment

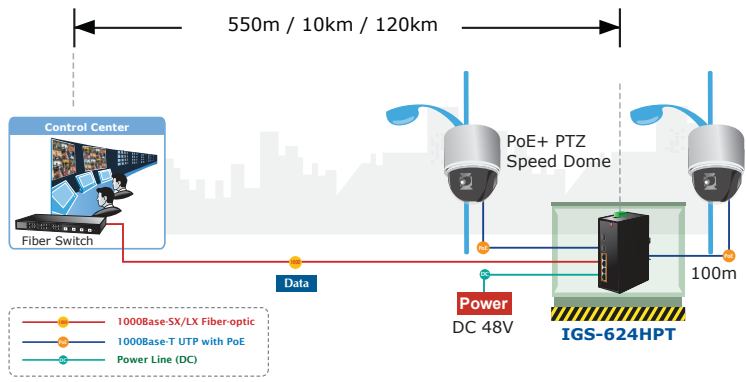

Harsh Climate

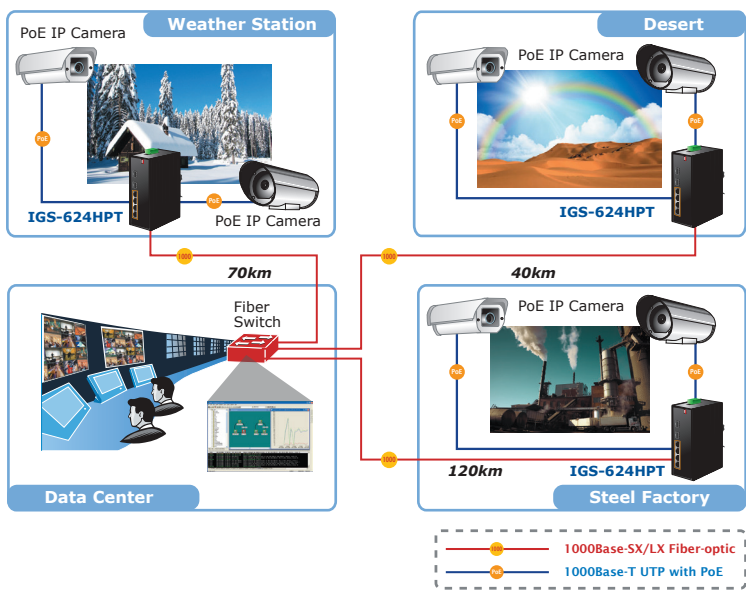

Installation Steps

- Step 1:** Unpack the Industrial Gigabit PoE+ Switch.
- Step 2:** Check whether the DIN-rail is screwed on the Industrial Gigabit PoE+ Switch. (Please refer to DIN-rail Mounting section for DIN-rail installation, if the DIN-rail is not screwed on the Industrial switch). If you want to wall-mount the Industrial Gigabit Ethernet Switch, please refer to Wall-mount Plate Mounting section for wall-mount plate installation.
- Step 3:** To hang the Industrial Gigabit PoE+ Switch on the DIN-rail track or wall, please refer to the Mounting Installation section.
- Step 4:** Power on the Industrial Gigabit PoE+ Switch. (Please refer to the Wiring of the Power Inputs section for power input) The power LED on the Industrial Gigabit PoE+ Switch will light up. Please refer to the LED Indicators section for the functions of LED lights.
- Step 5:** Prepare the twisted-pair, straight through Category 5 cable for Ethernet connection.
- Step 6:** Insert one side of Category 5 cable into the Industrial Gigabit PoE+ Switch Ethernet port (RJ45 port) and the other side of Category 5 cable to the network devices' Ethernet port (RJ45 port), e.g. switch, PC or Server. The UTP port (RJ45) LED on the Industrial Gigabit PoE+ Switch will light up when the cable is connected with the network device. Please refer to the **LED Indicators section for the functions of LED lights**.
- Step 7:** When all connections are set and all LED lights show normally, the installation is complete.



Note

Be sure the connected network devices support MDI/MDI-X. If it does not support, then use the crossover Category 5 Cable.

4. Switch Operation

4.1 Address Table

The Industrial Gigabit PoE+ Switch is implemented with an address table. This address table is composed of many entries. Each entry is used to store the address information of some nodes in the network, including MAC address, port no., etc. This information comes from the learning process of Industrial Gigabit PoE+ Switch.

4.2 Learning

When one packet comes from any port, the Industrial Gigabit PoE+ Switch will record the source address, port number and the other related information in address table. This information will be used to decide either forwarding or filtering for future packets.

4.3 Forwarding & Filtering

When one packet comes from some ports of the Industrial Gigabit PoE+ Switch, it will also check the destination address besides the source address learning. The Industrial Gigabit PoE+ Switch will look up the address table for the destination address. If not found, this packet will be forwarded to all the other ports except the port which this packet comes in. And these ports will transmit this packet to the network it connected. If found, and the destination address is located at a different port from this packet that comes in, the Industrial Gigabit PoE+ Switch will forward this packet to the port where this destination address is located according to the information from address table. But, if the destination address is located at the same port with this packet that comes in, then this packet will be filtered; thereby increasing the network throughput and availability.

4.4 Store-and-Forward

Store-and-Forward is one type of packet-forwarding techniques. A Store-and-Forward Industrial Gigabit PoE+ Switch stores the incoming frame in an internal buffer and does the complete error checking before transmission. Therefore, no error packets occur. It is the best choice when a network needs efficiency and stability.

The Industrial Gigabit PoE+ Switch scans the destination address from the packet-header, searches the routing table provided for the incoming port and forwards the packet, only if required. The fast forwarding makes the switch attractive for connecting servers directly to the network, thereby increasing throughput and

availability. However, the switch is most commonly used to segment existing hubs, which nearly always improves the overall performances. An Ethernet Switching can be easily configured in any Ethernet network environment to significantly boost bandwidth using the conventional cabling and adapters.

Due to the learning function of the Industrial Gigabit PoE+ Switch, the source address and corresponding port number of each incoming and outgoing packet are stored in a routing table. This information is subsequently used to filter packets whose destination address is on the same segment as the source address. This confines network traffic to its respective domain and reduces the overall load on the network.

The Industrial Gigabit PoE+ Switch performs "**Store and Forward**"; therefore, no error packets occur. More reliably, it reduces the re-transmission rate. No packet loss will occur.

4.5 Auto-Negotiation

The STP ports on the Industrial Gigabit PoE+ Switch have built-in "**Auto-negotiation**". This technology automatically sets the best possible bandwidth when a connection is established with another network device (usually at Power On or Reset). This is done by detecting the modes and speeds at the second of both devices that are connected and capable of. Both 10BASE-T and 100BASE-TX devices can connect with the port in either half- or full-duplex mode. 1000BASE-T can be only connected in full-duplex mode.

5. Troubleshooting

This chapter contains information to help you solve issues. If the Industrial Gigabit PoE+ Switch is not functioning properly, make sure the Industrial Gigabit PoE+ Switch is set up according to instructions in this manual.

The Link LED does not light up

Solution:

Check the cable connection and also try to swap one new cable.

Performance is bad

Solution:

Check the speed duplex mode of the partner device. The Industrial Gigabit PoE+ Switch runs in auto-negotiation mode and if the partner is set to half duplex, then the performance will be poor.

100BASE-T port link LED lights up, but the traffic is irregular

Solution:

Check whether the attached device is not set to full duplex. Some devices use a physical or software switch to change duplex modes. Auto-negotiation may not recognize this type of full-duplex setting.

Why the Industrial Gigabit PoE+ Switch doesn't connect to the network

Solution:

Check each port LED on the Industrial Gigabit PoE+ Switch. Try another port on the Industrial Gigabit PoE+ Switch. Make sure the cable is installed properly. Make sure the cable is the right type. Turn off the power. After a while, turn on the power again.

Why after my PoE PD device is connected to IGS-504HPT/IGS-624HPT, it cannot power on?

Solution:

1. Please check the cable type of the connection from IGS-504HPT/IGS-624HPT (port 1 to port 4) to the other end. The cable should be an 8-wire UTP, Category 5 or above, EIA568 cable within 100 meters. A cable with only 4-wire, short loop or over 100 meters, all will affect the power supply.
2. Please check and assure the device is fully complied with IEEE 802.3af/IEEE 802.3at standard.

Can I install MGB-SX or other non wide temperature SFP module into SFP slot of Industrial Gigabit PoE+ Switch?

Solution:

Yes, you can. However, since the MGB-SX and other non wide temperature SFP modules cannot operate under -40 degrees C, it must be brought to attention. Please pay attention to this point.

6. Cable Connection Parameters

The wiring details are as shown below:

100FX Fiber Optic Cables:

Standard	Fiber Type	Cable Specification
100BASE-FX (1310nm)	Multi-mode	50/125µm or 62.5/125µm
	Single-mode	9/125µm
100BASE-BX-U (TX :1310/RX :1550nm) 100BASE-BX-D (TX :1550/RX :1310nm)	Single-mode	9/125µm

1000X Fiber Optic Cables:

Standard	Fiber Type	Cable Specification
1000BASE-SX (850nm)	Multi-mode	50/125µm or 62.5/125µm
1000BASE-LX (1310nm)	Multi-mode	50/125µm or 62.5/125µm
	Single-mode	9/125µm

Wiring Distances:

Standard	Fiber	Diameter (micron)	Modal Bandwidth (MHz * km)	Max. Distance (meters)
1000BASE-SX	Multi-mode	62.5	100	220
		62.5	200	275
		50	400	500
		50	500	550
1000BASE-LX	Multi-mode	62.5	5	550
		50	4	
		50	5	
	Single-mode	9	N/A	5000
1000BASE-ZX	Single-mode	9	N/A	~70,000



Note

The single-mode port (1000BASE-LX port) of the IGS-624HPT provides an additional margin allowing 10/20/30/40/50/70/120 km Gigabit Ethernet to link to single mode fiber.

APPENDIX A: Networking Connection

A.1 PoE RJ45 Port Pin Assignments (End-Span)

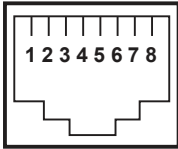
	PIN NO	RJ45 POWER ASSIGNMENT
	1	• Power +
	2	• Power +
	3	• Power -
	6	• Power -

A.2 Switch's RJ45 Pin Assignments

1000Mbps, 1000BASE-T

Contact	MDI	MDI-X
1	BI_DA+	BI_DB+
2	BI_DA-	BI_DB-
3	BI_DB+	BI_DA+
4	BI_DC+	BI_DD+
5	BI_DC-	BI_DD-
6	BI_DB-	BI_DA-
7	BI_DD+	BI_DC+
8	BI_DD-	BI_DC-

10/100Mbps, 10/100BASE-TX

RJ45 Connector pin assignment		
Contact	MDI Media Dependent Interface	MDI-X Media Dependent Interface -Cross
1	Tx + (transmit)	Rx + (receive)
2	Tx - (transmit)	Rx - (receive)
3	Rx + (receive)	Tx + (transmit)
4, 5	Not in use	
6	Rx - (receive)	Tx - (transmit)
7, 8	Not in use	

A.3 RJ45 Cable Pin Assignments

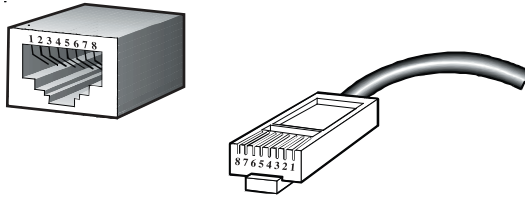

The standard RJ45 receptacle/connector

There are 8 wires on a standard UTP/STP cable and each wire is color-coded. The following shows the pin allocation and color of straight cable, and crossover cable connection:



Figure A-1: Straight-through and Crossover Cable

Please make sure your connected cables are with the same pin assignment and color as the above picture before deploying the cables into your network.